

Memo



Date: July 15, 2010

To: City Manager

From: Community Sustainability Division

File No: Z10-0053

Applicant: New Town Planning Services
(Jeanette Elmore)

At: 195 Swick Road

Owner(s): Cindy Lee Ferguson

Purpose: To rezone the subject property from RR1 - Rural Residential 1 zone to the RR1s - Rural Residential 1 with a secondary suite zone to construct a secondary suite in an accessory building.

Existing Zone: RR1 - Rural Residential 1 zone

Proposed Zone: RR1s - Rural Residential 1 with a secondary suite zone

Report Prepared by: Birte Decloux

1.0 RECOMMENDATION:

THAT Rezoning Application No. Z10-0053 to amend the City of Kelowna Zoning Bylaw No. 8000, by changing the zoning classification of Lot 3, Section 16, Township 28, SDYD Plan 17902 located at Swick Road, Kelowna, BC, from the RR1 - Rural Residential 1 zone to the RR1s - Rural Residential 1 with a secondary suite zone be considered by Council;

AND THAT the zone amending bylaw be forwarded to a Public Hearing for further consideration;

AND THAT a building permit for the suite be applied for prior to final adoption of the zone;

AND THAT final adoption of the zone amending bylaw be considered subsequent to the requirements of the Development Engineering Department and the Environmental Branch being completed to their satisfaction.

2.0 SUMMARY:

This application is seeking to rezone the subject property from the RR1 - Rural Residential 1 zone to the RR1s - Rural Residential 1 with a secondary suite zone to construct a secondary suite in an accessory building.

3.0 BACKGROUND & PROPOSAL:

A single family residence is located near the lakeshore, which is accessed from Swick Road via an easement that crosses neighbouring properties. The property is currently used as a vacation home, however, the owner intends to relocate here permanently. In 2009, an accessory building used as a garage and office was approved for the middle of the site.

9v

The purpose of this application is to rezone the subject property to accommodate the construction of a caretaker's cottage in the southeast corner of the property. The one bedroom cottage is proposed to have a double garage, and terraces on two sides with fully opening floor to ceiling windows. An outdoor fireplace is provided on the covered terrace. The siting of the secondary suite is on the south portion of the property far removed from the principal dwelling with its own access and parking off Lakeshore Road.

The proposed application meets the requirements of RR1s- Rural Residential 1 with a secondary suite zone follows:

Zoning Bylaw No. 8000		
CRITERIA	PROPOSAL	RR1(S) ZONE REQUIREMENTS (FOR SECONDARY SUITE IN ACCESSORY BUILDING)
Subdivision Regulations		
Lot Area	84,949 m ²	8000 m ²
Lot Width	170.22 m	40 m
Lot Depth	259.49 m	30 m
Development Regulations		
Site Coverage (buildings)	2 %	10%
Site Coverage (buildings/parking)	3 %	50%
Existing Dwelling		
Height	9.5 m	Lessor of 2 ½ storeys /9.5 m
Total Floor Area	325 m ²	
Proposed Secondary Suite in an Accessory Building		
Height	5.58 m	6.0 m
Total Floor Area	89.28 m ² / 27.5%	90m ²
Front Yard	19.6 m	6.0 m to a garage
Side Yard (w)	148 m	3.0 m
Side Yard (e)	6.09 m	3.0 m
Rear Yard	223.4 m	3 m
Separation	50 m to nearest building/garage	5.0 m
Other Requirements		
Parking Stalls (#)	Double garage provided for the suite; additional garages on site for principal dwelling	3 spaces
Private Open Space	meets requirements	30 m ² of private open space per dwelling

4.1 Site Context

The subject property is located on the north side of Lakeshore Road, in the south west mission area, just west of Bertram Creek Park. More specifically, the adjacent land uses are as follows:

North	W1	Recreational Water Use - Okanagan Lake
South	RR1	Rural Residential 1
	A1	Agriculture 1
East	RU1	Rural Residential 1
West	RU1	Rural Residential 1

4.2 Site Location: 195 Swick Road

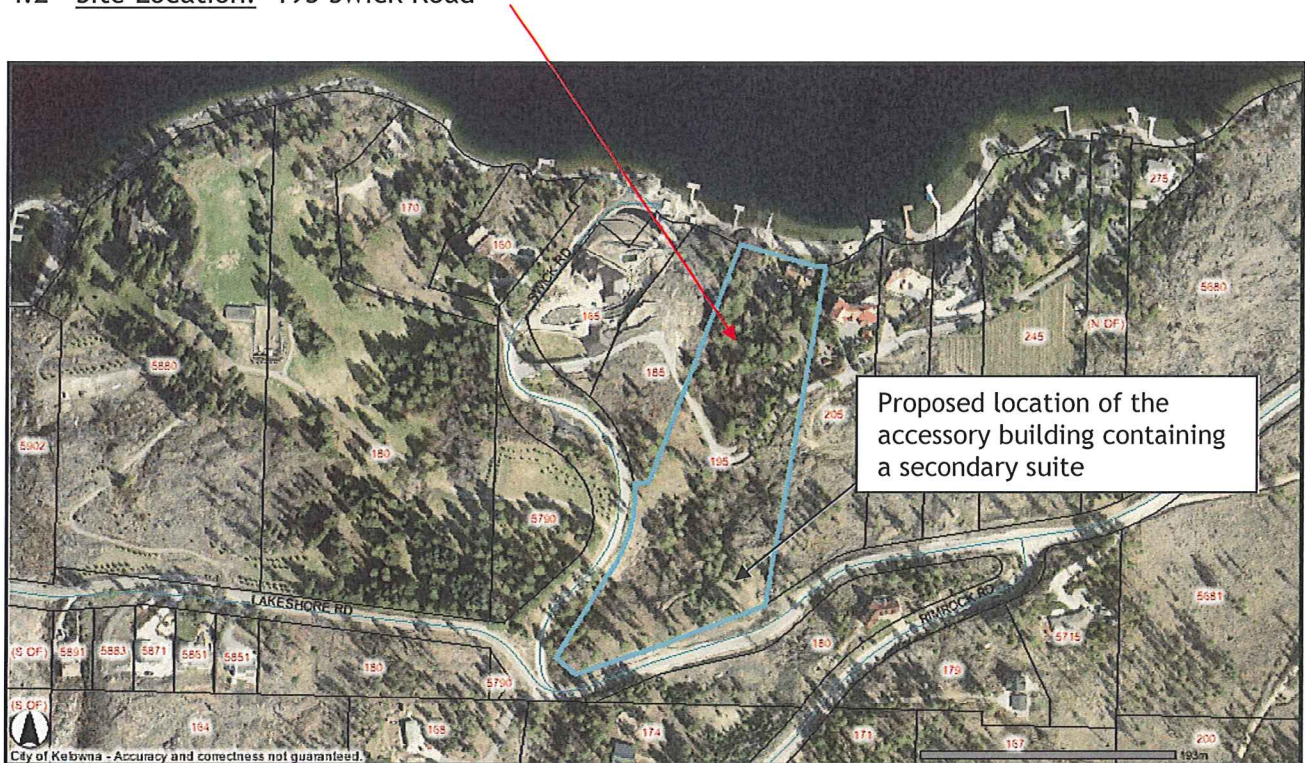

5.0 CURRENT DEVELOPMENT POLICY

The purpose is to provide a zone for country residential development, and complementary uses, on larger lots in areas of high natural amenity and limited urban services.

Kelowna 2020 - Official Community Plan

The subject property is designated as Future Urban Reserve in the Official Community Plan. This is land that has future development potential but is not projected for development within the Official Community Plan 20-year time horizon. Relevant policies are included below.

Housing Polices:

Integration¹. Encourage the sensitive integration of different housing forms in the various sectors of the City, in support of neighbourhood diversity and healthy communities;

Secondary Suites². Encourage, under the conditions stipulated in the Zoning Bylaw, the creation of secondary suites.

6.0 TECHNICAL COMMENTS

The application has been submitted to various technical agencies and City departments, and the following relevant comments have been submitted:

6.1 Development Engineering**Domestic Water and Fire Protection**

The development is serviced by a private water system and subject to approval of the Provincial Public Health Officer. Please contact the Public Health Officer.

Sanitary Sewer

Sanitary sewage is to be handled by an on-site sewage disposal system subject to approval of the Provincial Public Health Officer. Please contact the Public Health Officer. *Record of sewerage system dated June 7, 2010 has been received.*

Site Related Issues

Provide on-site parking for the proposed dwelling.

Electric Power and Telecommunication Services

It is the applicant's responsibility to make a servicing application with the respective electric power, telephone and cable transmission companies to arrange for service upgrades to these services which would be at the applicant's cost.

6.2 Fire Department

No objections

6.3 Environment & Land Use Branch

Recommend that riparian protection and enhancement measures in consideration for allowing increased density on the balance of the subject property. *A separate development permit has been required to address these concerns.*

6.4 Bylaw Services

No concerns

6.5 Building and Permitting Branch

1) Development Cost Charges (DCC's) are required to be paid prior to issuance of any Building Permits.

2) Full Plan check for Building Code related issues will be done at time of Building Permit applications.

3) Are there any retaining walls? Finished grade to slope away from dwelling as per the 2006 edition of the British Columbia Building Code.

¹ Official Community Plan, Policy #8-1.44

² Official Community Plan, Policy #8-1.47

7.0 LAND USE MANAGEMENT DEPARTMENT COMMENTS

The City encourages the sensitive integration of secondary suites within existing neighbourhoods and where services are provided. Although this area of Kelowna has little in urban services, considering the large size of the subject property, little impact if any is expected by the addition of a secondary suite. Located at the top of the property along Lakeshore Road, the secondary suite in an accessory building will lend a street presence to an area where most dwellings are located along the lake front.

To facilitate the proposed development, a Natural Environment Development Permit and a Form and Character Development Permit are required, to be executed at a staff level, which will include an Environmental Assessment report.

Submitted by:



Danielle Noble
Manager, Urban Land Use

Approved for inclusion:



Shelley Gambacort
Director, Land Use Management

Attachments:

Subject Property Map
Site Plan
Suite Floor Plans
Site Photo

Application Chronology:

Date Application Accepted: June 2010
Revised drawings received: July 13, 2010

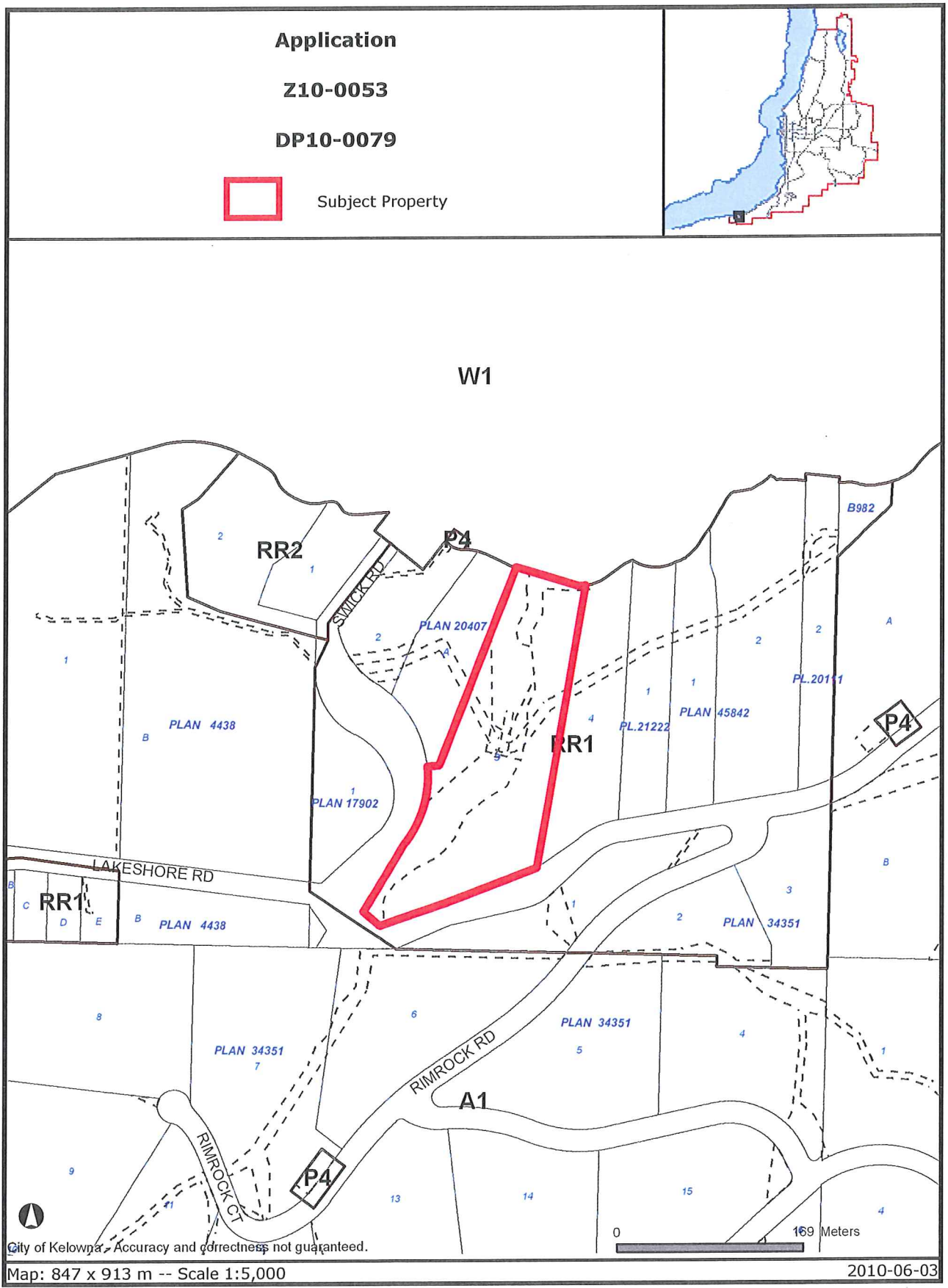

Certain layers such as lots, zoning and dp areas are updated bi-weekly. This map is for general information only. The City of Kelowna does not guarantee its accuracy. All information should be verified.

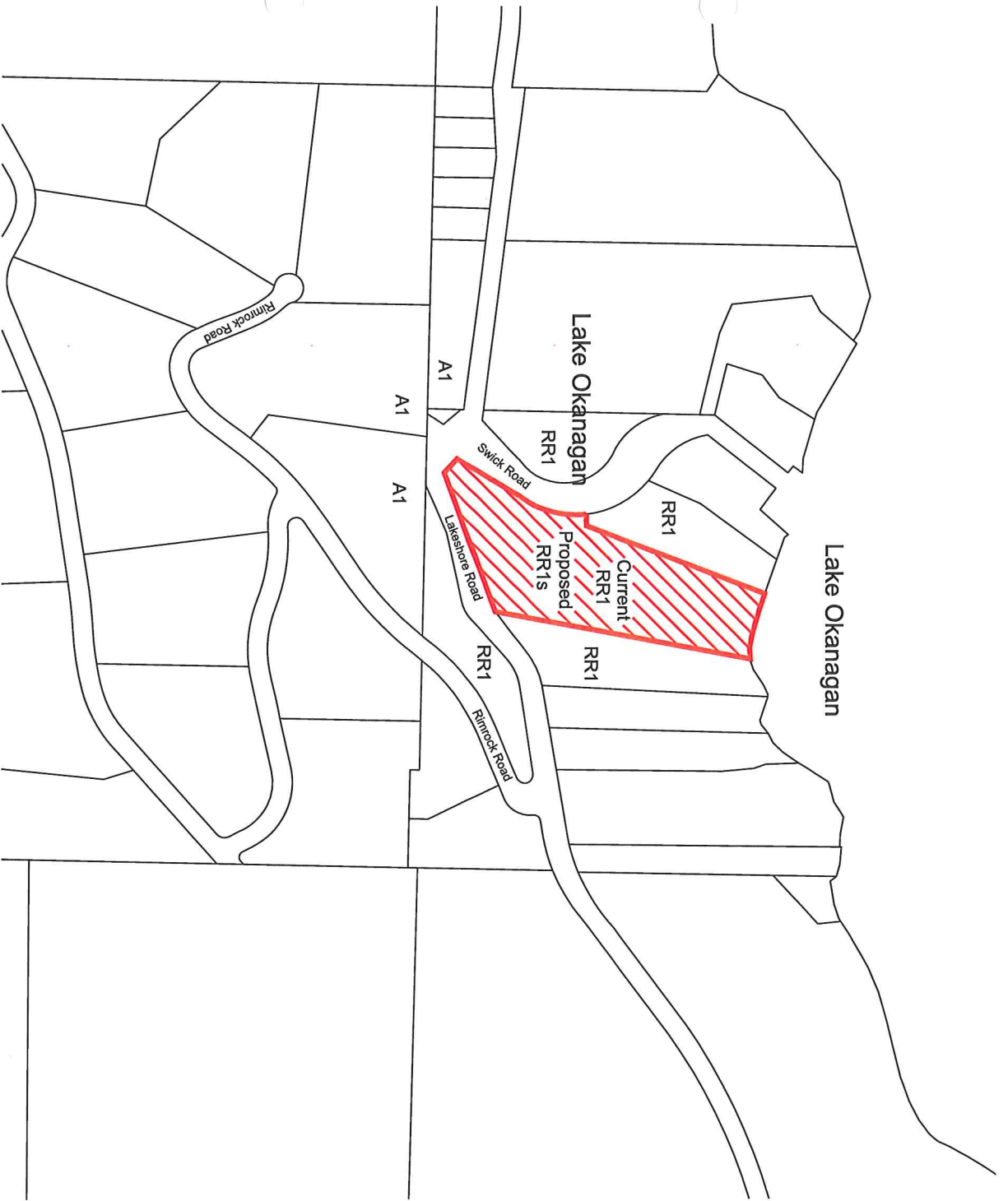

NOTES
 1. This drawing is the property of New Town Planning Services Ltd. and shall not be reproduced, stored in a retrieval system, or transmitted in any form or by any means, electronic, mechanical, photocopying, recording, or by any information storage and retrieval system, without the prior written permission of New Town Planning Services Ltd. This drawing is void if not signed.

No.	Date	Description
REVISIONS		
project title		
195 Swick Road		
Project no. 1529		
File no. 1529 - base		
drawing title		
Rezoning		
Context Plan		
designed	K.F.	checked
drawn	R.P.B.	approved
scale	1:4000	date
number		2010-04-21

Map 01



NEW TOWN
 ARCHITECTURE
 URBAN PLANNING

1450 PANDOSY STREET
 KESWICK, B.C. V1Y 1T3
 P: 250-860-5185
 F: 250-860-0985
 www.newtownservices.net

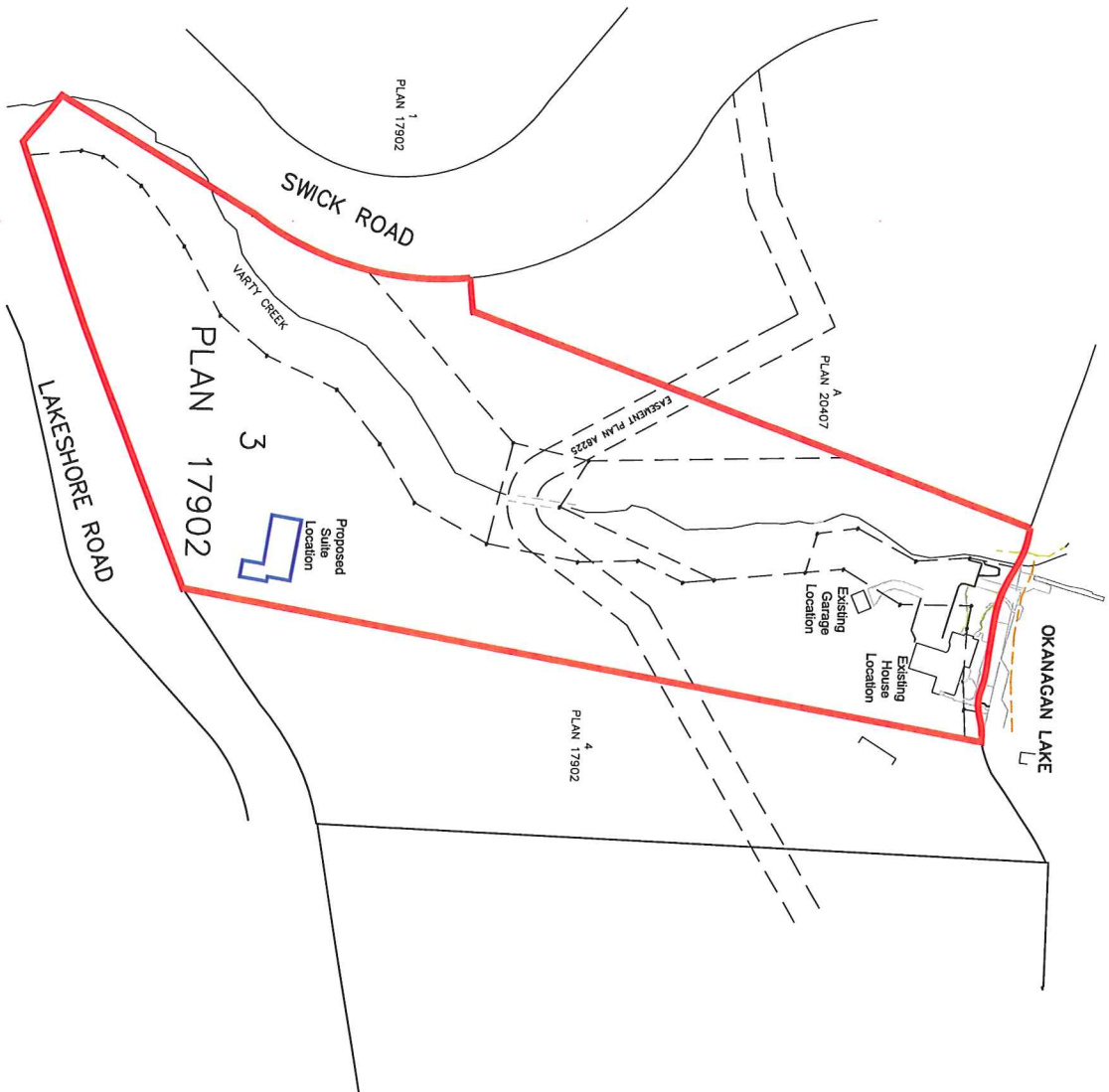

NOTES
 1. This drawing is prepared by the author and is not to be used for any other purpose without the written consent of the author.
 2. This drawing is not to be used for any other purpose without the written consent of the author.
 3. This drawing is not to be used for any other purpose without the written consent of the author.
 4. This drawing is not to be used for any other purpose without the written consent of the author.

No. Date Description
 REVISIONS

project title
 195 Swick Road

Project no. 1523

File no. 1529 - base

drawing title
 Rezoning

Site Plan

designed by K.F. R.P.B.
 date 1:1500
 checked 2010-04-21
 revision

Map 02



NEW TOWN
 ARCHITECTURE
 URBAN PLANNING

1450 PANDOSY STREET
 KELLOWNA, B.C. V1Y 1P3
 T : 250-860-8185
 F : 250-880-0985
 WWW.NEWTOWNARCHITECTURE.COM

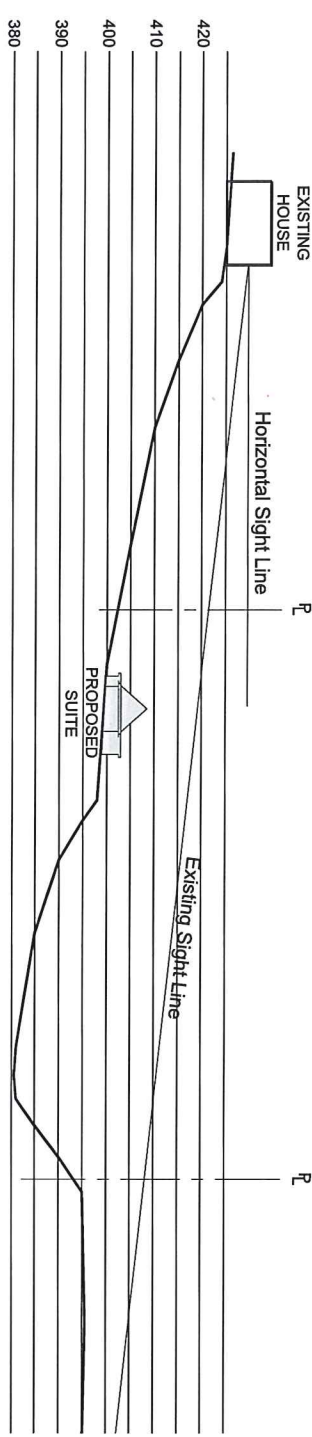
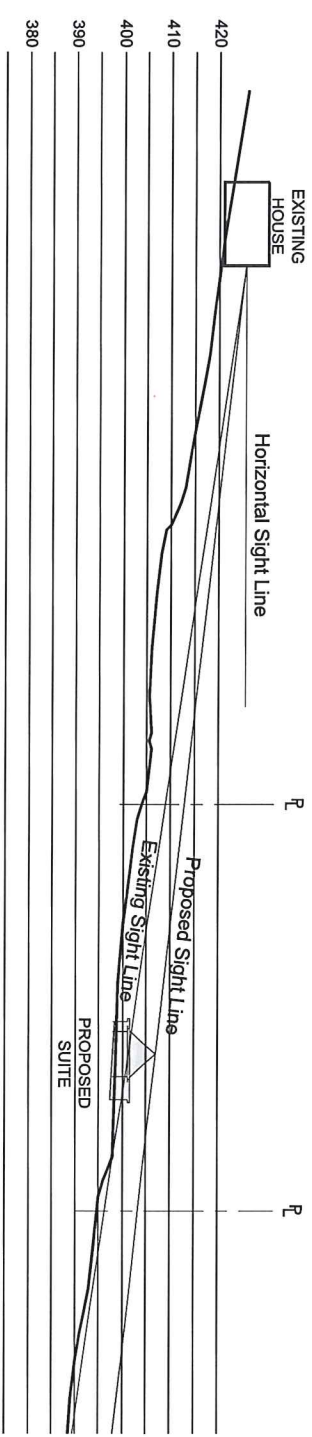
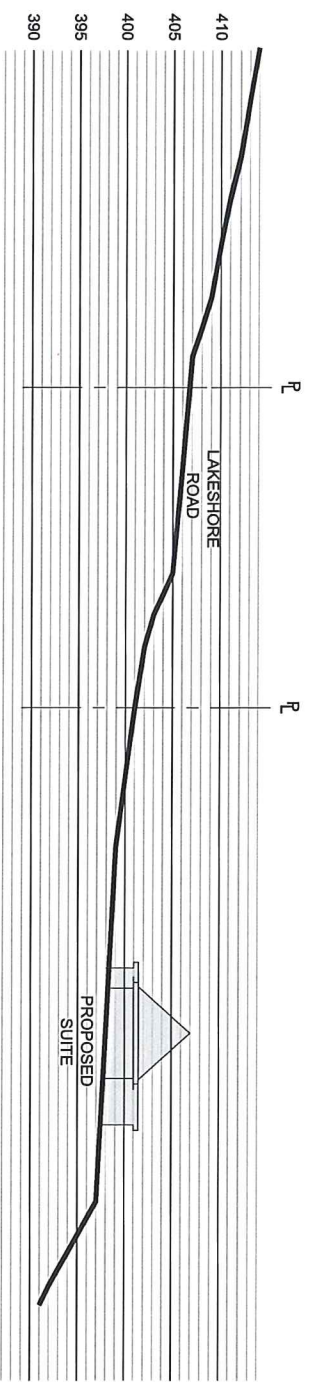

NOTE:
 This drawing is prepared by the author and is not a contract document. It is intended to provide a visual representation of the proposed project and is not intended to be used for any other purpose. The author assumes no responsibility for any errors or omissions in this drawing. The user of this drawing is advised to verify all information and to consult with the appropriate authorities before using this drawing for any purpose.

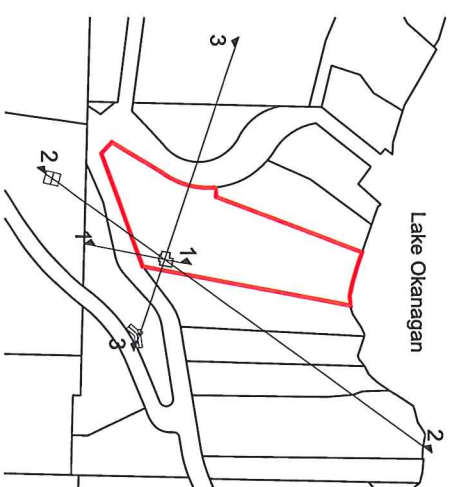

No.	Date	Description
REVISIONS		

project title: 195 Swick Road

Project no.: 1529

File no.: 1529 - base

drawing title: Rezoning

Site Section

prepared: K.F. R.P.B.

date: AS NOTED

revision: 2010-05-19

NEW TOWN
 ARCHITECTURE
 URBAN PLANNING

1450 PANDOSY STREET
 KELLOWNA, B.C. V1Y 1P3
 T: 250-860-8115
 F: 250-860-0955
 www.newtownservices.net

Fig. 01

REVISED PLANS

JUL 13 2010

CITY OF KELOWNA
Land Use Management

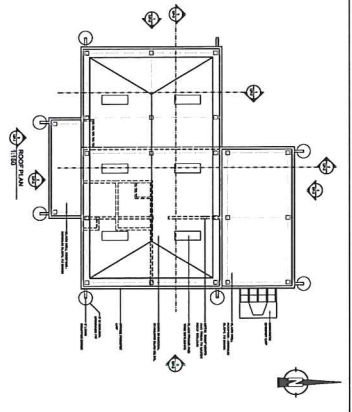
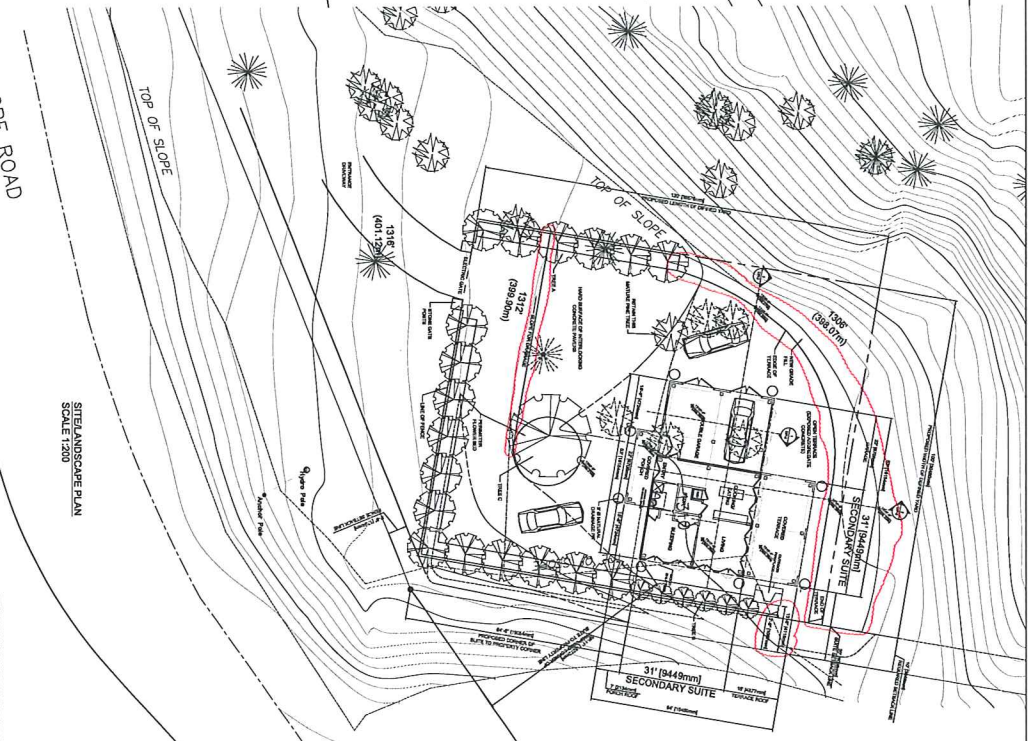
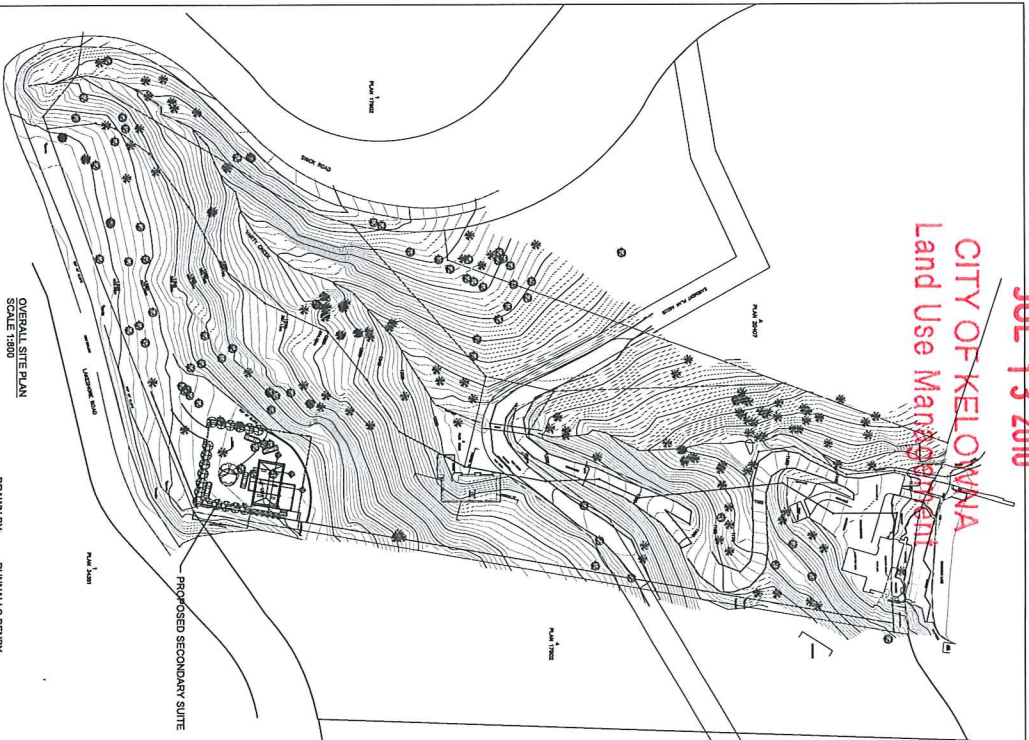

LOT AREA	30,023 sq.m. (923,194 sq.ft.)
GROSS FLOOR AREA	88,28 sq.m. (951 sq.ft.)
PROPOSED SECONDARY SUITE	62,36 sq.m. (672 sq.ft.)
PROPOSED DOUBLE GARAGE	191,46 sq.m. (2067 sq.ft.)
EXISTING GARAGE AT MID POINT OF SITE	238,8 sq.m. (2569 sq.ft.)
EXISTING MAIN HOUSE (NEAR LINE)	20,82 sq.m. (2248 sq.ft.)
EXISTING GARAGE NEAR MAIN HOUSE	597,47 sq.m. (6,431,33 sq.ft.)
TOTAL BUILDING AREA	597,47 sq.m. (6,431,33 sq.ft.)
LOT COVERAGE BEFORE SECONDARY SUITE	1,48%
LOT COVERAGE WITH SECONDARY SUITE	2%
FLOOR AREA RATIO	0,2%
PROPOSED SECONDARY SUITE/LOT AREA	1,120,3 sq.m. (12,145 sq.ft.)
PRIVATE OPEN SPACE	-152,84 sq.m. (1,643 sq.ft.)
MINUS PROPOSED SUITE	975,66 sq.m. (10,502 sq.ft.)
PARKING AND LOADING SPACES	RESIDENTIAL DOUBLE GARAGE

SYMBOL	COMMON NAME	BOTANICAL NAME	SIZE	QUANTITY
Tree A	xxx	yyy	mm OAL	18
Tree B	xxx	yyy	mm OAL	9
Tree C	xxx	yyy	mm OAL	1

Studio D + G Forsyth
2114 - 14th STREET SW
V7Y 4G9
Kelowna, BC
Tel: 432 232811

CIVIC ADDRESS: 195 SWICK ROAD
KELOWNA, BC

LEGAL DESCRIPTION: LOT: 3
SECTION: 16
TOWNSHIP: 18
PLAN: 782

DRAWN BY: RAINALD & DENNY
BOTANICAL LAND SURVEYORS
2594 LAWRENCE AVENUE
KELOWNA, B.C.
V1Y 6Z2

DATE: AUGUST 28, 2009

FILE NO: 12918

CONSULTANTS:

REVISIONS:
8 JUL '10
-ADDED DIMENSION FOR CHIMNEY SETBACK
-REDUCED HEIGHT OF CHIMNEY TO 6m
-ADDED SETBACK DIMENSIONS FOR THE GARAGE
-ADDED DRAINAGE SLOPE AT FRONT PAVED AREA

PROJECT: ONE STOREY SECONDARY SUITE
DRAWING: SITELANDSCAPE/ROOF PLAN
DATE: 18/09/2010
SCALE: AS NOTED

DRAWN BY: JN
CHECKED BY: GF
DO NOT SCALE DRAWINGS
DIMENSIONS BELONG TO THE DESIGNER

DP-1

Studio D + G Forsyth
 2215 14th STREET SW
 CALGARY AB CANADA
 T2M 0K2
 Phone: 403.270.0881
 Fax: 403.270.0881

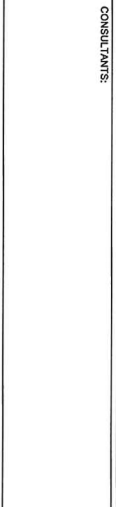

CONSULTANTS:
 REVISIONS:
 6 JUL '10
 -ADDED DIMENSION FOR CHIMNEY SETBACK
 -REDUCED HEIGHT OF CHIMNEY TO 6m
 -REMOVED RETAINING WALL AND CREATED
 -ADDED SIGNAGE FOR THE FRONT
 -ADDED DRIVEWAY SIGNAGE FROM
 PAVED AREA

PROJECT:
 ONE STOREY SECONDARY SUITE
 DRAWING:
 FLOOR PLAN & SECTIONS
 DATE:
 18/05/2010
 SCALE:
 1:100

DRAWN BY: JH
 CHECKED BY: JH
 DO NOT SCALE DRAWINGS
 DIMENSIONS TO BE GIVEN
 RELIANCE TO THE DESIGNER
 DP-2

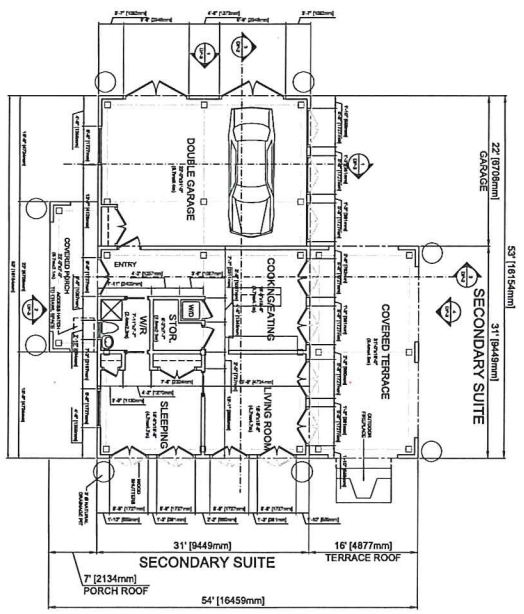
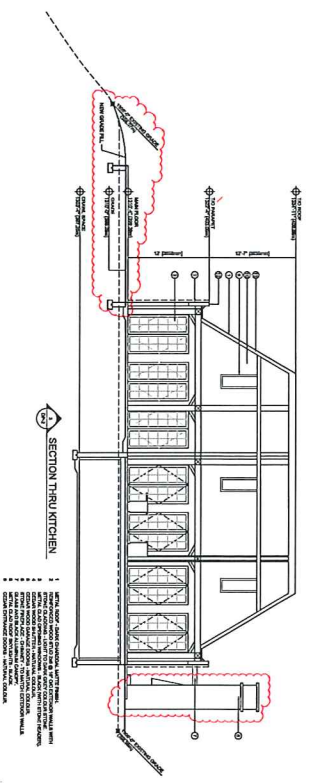
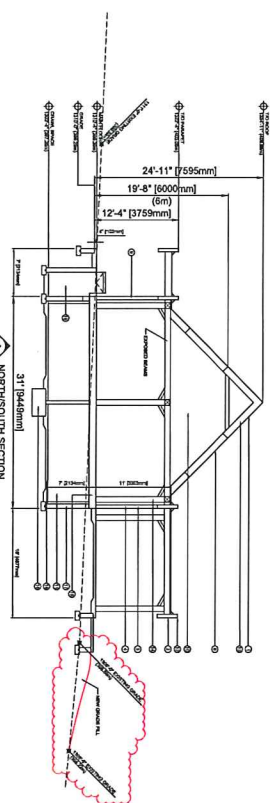
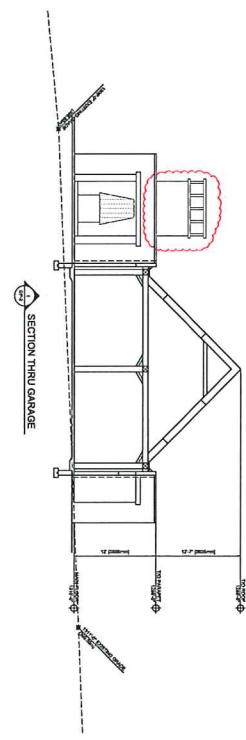

Studio D + G Forsyth
 2218 - 18A STREET SW
 CALGARY AB CANADA
 Tel: 403.270.8888
 Fax: 403.239.2881



CONSULTANTS:
 REGIONS:
 8-ALL-10
 -ADDED DIMENSION FOR CHIMNEY SETBACK
 -REDUCED HEIGHT OF CHIMNEY TO 6m
 -REMOVED RETAINING WALL AND CREATED
 -ADDITIONAL SLOPES FOR THE GRADE
 -PAVED AREA

PROJECT:
 ONE STOREY SECONDARY SUITE
DRAWING:
 ELEVATIONS
DATE:
 18/05/2010
SCALE:
 1:100

DRAWN BY: JNF
 CHECKED BY: JNF
 DO NOT SCALE DRAWINGS
 BELONGS TO THE DESIGNER
DP-3

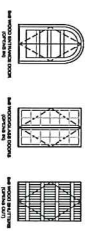
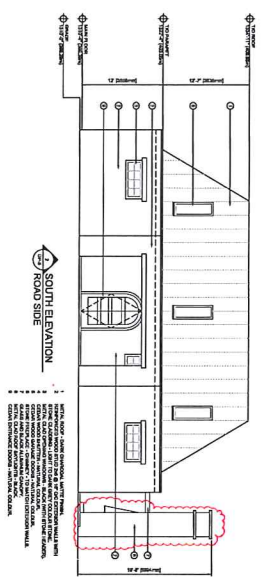
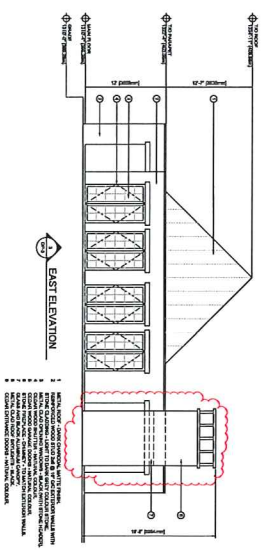
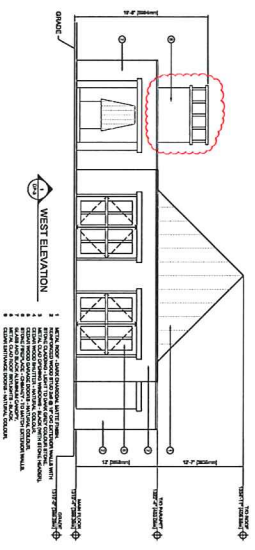

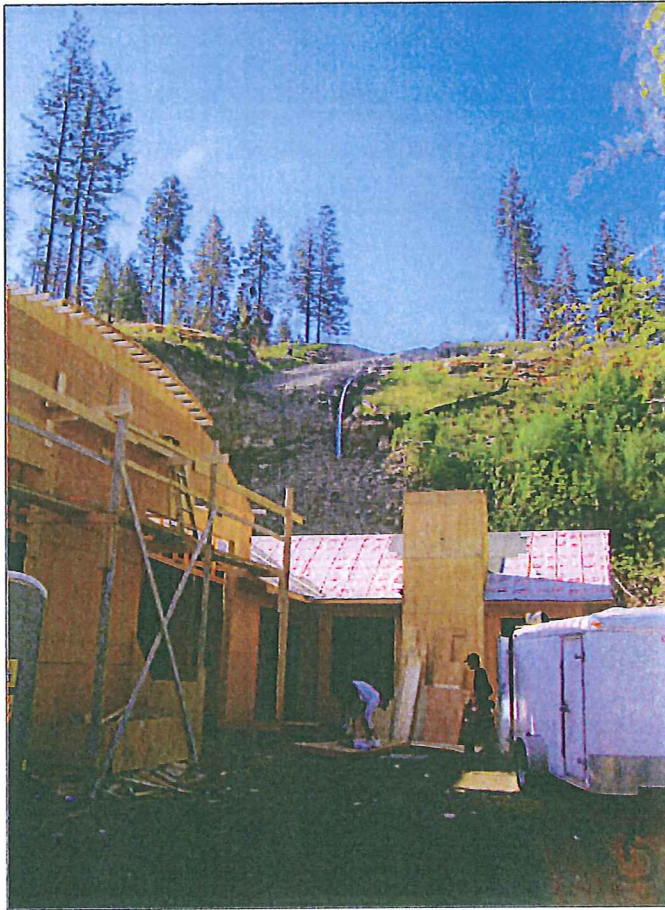

Left: Looking up towards the proposed suite location from the common easement



Right: The main house at 195 Swick Road



Above: Proposed secondary suite location, from Lakeshore Road



Above: View of the site and proposed suite location from Swick Road



Above: Across Lakeshore Road from the site



Above: Vegetation in the vicinity of Varty Creek

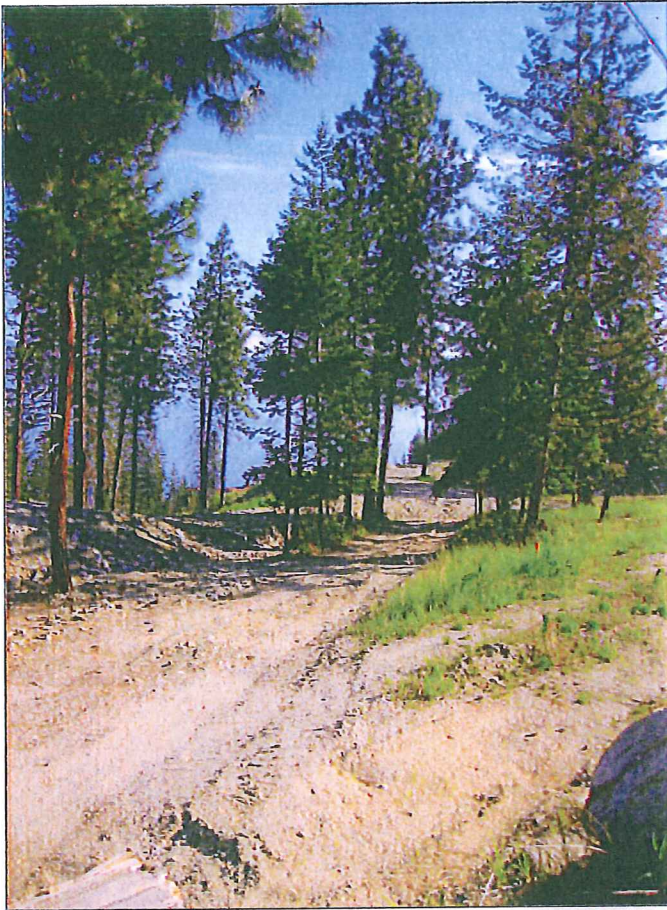

Left: Potential driveway access to suite from Lakeshore Road

Right: View from Rimrock Road looking down towards the site

